

Series  
MA MAb  
MSR MSS

 EuroVent



Aluminium Blower

# HOUSING POSITION AND ROTATION

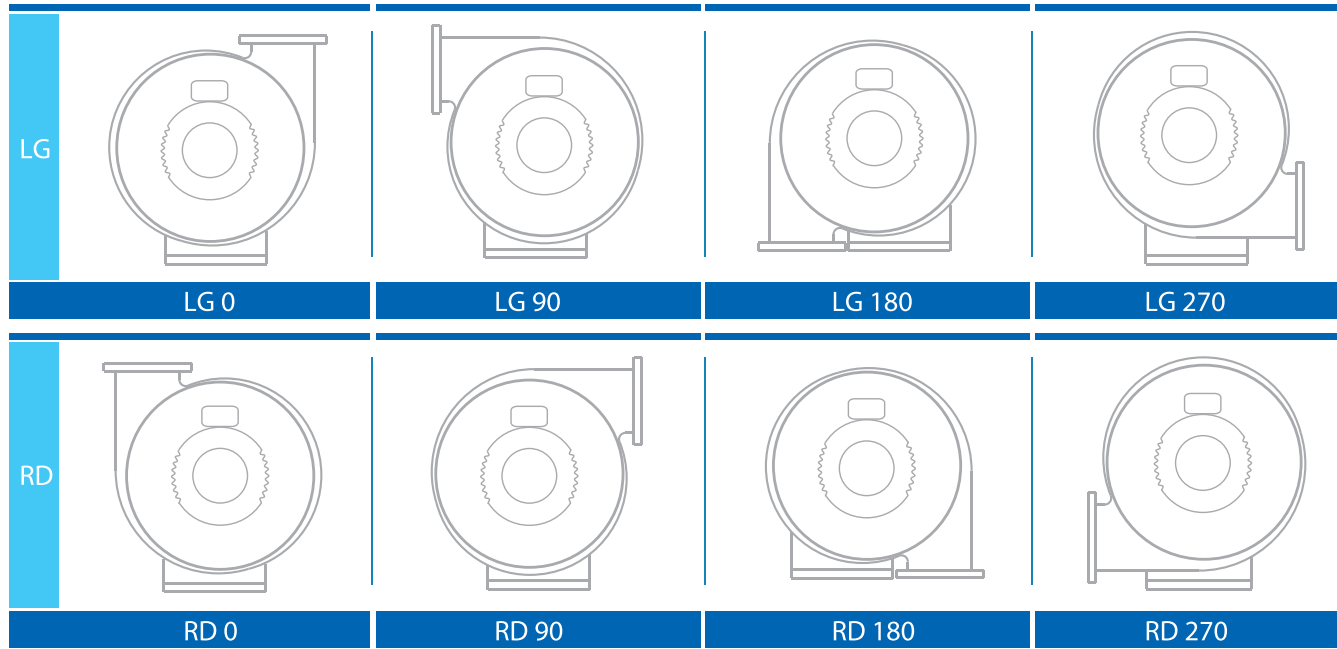

In the standard version, the equipment is supplied with the terminal box position 270° (top), look at driver side.

## Housing positions, terminal box positions, cable entry

### Housing Positions

The housing position is determined when facing the Driven side

Positions RD = Clockwise rotation

Positions LG = Anti-clockwise rotation

## Influence of the density

The following tables show the characteristics of an operating device at air 15 °C , barometric pressure 760 mm Hg , specific gravity 1,226 Kg/m<sup>3</sup> . If customer wishes get different performances with intermediary value in respect of the value shown in the tables or if he prefers a device operating with air suction at different temperature in respect of 15 °C and with different specific gravity in respect of 1,226.

## Rotation speed

The standard blower are fitted with 2 poles motor. For change-pole motor ( 4 Poles ) or use variable speed drive the total pressure , the volumetric flow rate and power requirement change as follows.

### Variation of rotation speed(n) with air specific gravity constant.

1. The delivery (V) varies directly with rotations ratio.

$$V_1 = V \cdot \frac{n^1}{n}$$

2. The pressure varies with square number of rotations ratio :

$$Pt_1 = Pt \left( \frac{n^1}{n} \right)^2$$

3. The energy (P) varies with cube of rotations ratio :

$$P_1 = P \cdot \left( \frac{n^1}{n} \right)^3$$

## Variations of specific gravity (γ) of the air when rotation speed is constant.

1. The delivery (V) remains constant.
2. The pressure (pt) and the energy (P) vary directly with the ratio of specific gravities.

$$Pt_1 = Pt \cdot \frac{\gamma^1}{\gamma} \quad P_1 = P \cdot \frac{\gamma^1}{\gamma}$$

The specific gravity of the air at different temperatures is obtained through the formula

$$\gamma = \frac{1,293 \cdot 273}{(273+t)} \text{ (kg/m}^3\text{)}$$

The air density depending on a change of the atmospheric pressure is given by the following formula

$$\gamma = \frac{Pb \cdot 13.56}{29.27 \cdot (273+t)} \text{ (kg/m}^3\text{)}$$

### Where :





- γ = specific gravity at 0 °C
- 1,293 = specific gravity of the air at 0 °C
- t = air temperature indicated in °C
- 273 = absolute zero
- Pb = atmospheric pressure mm Hg

## Eurovent Aluminium blowers offer

- Logical performance graduation
- Ready-to-install design with three or single phase a.c. motors
- High performance at compact design
- Long service life with low operation cost
- High efficiency
- Favourable noise characteristics
- Robust cast aluminium casings
- Useful accessories

# TECHNICAL INFORMATION AND PERFORMANCE CURVE

## Direct Drive Aluminium Blower

Casing			MA 05 A /S
			

/S : With single phase AC motor  
 /T : With three phase AC motor

Motor size

Construction size

Model

MA : Backward impeller  
 MSR : Open blade impeller for conveying  
 MSS : Open blade impeller for conveying (open casing design)

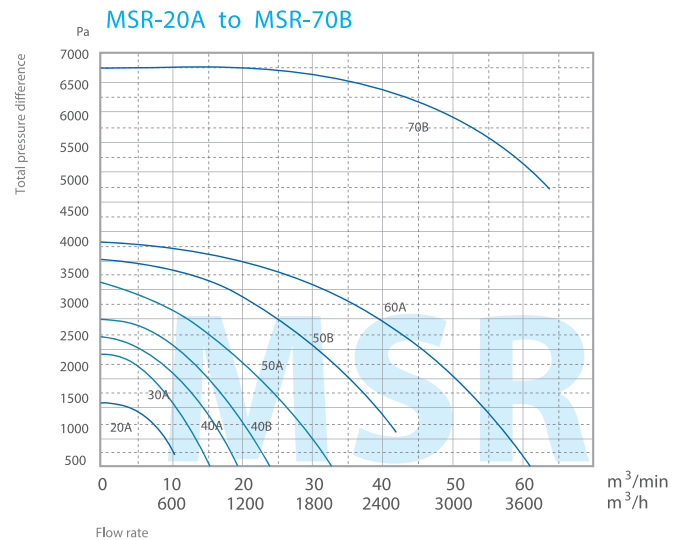
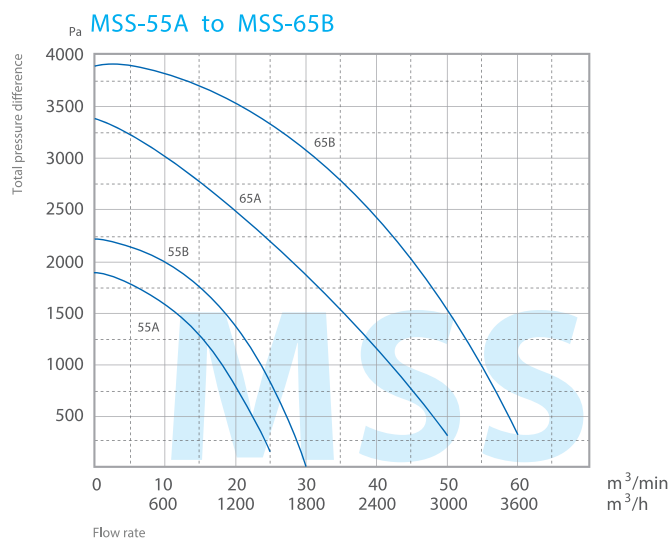
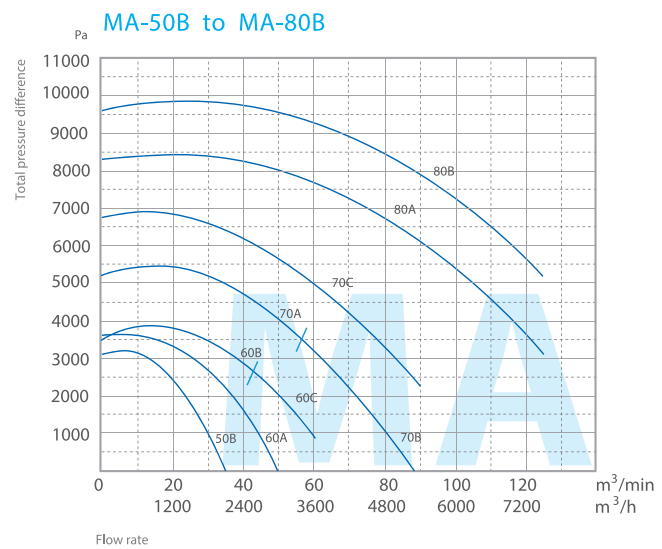
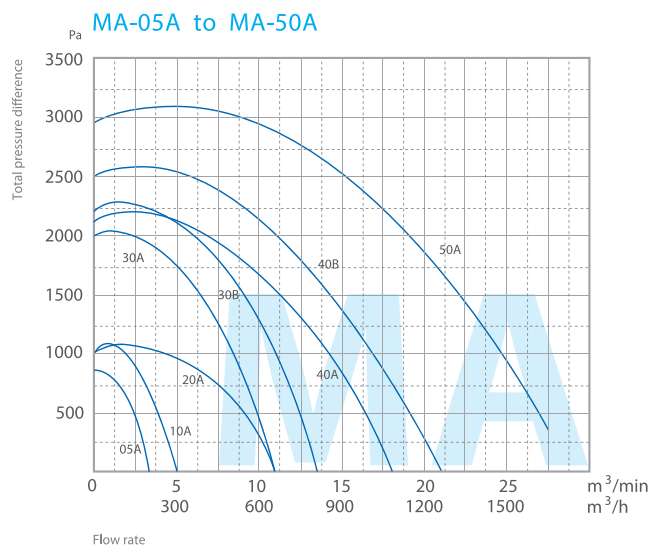

# TECHNICAL INFORMATION MA

Type	Max flow rate	Total pressure difference	Voltage	Frequency	Current consumption	Number of revolutions	Motor rating	Capacitor	Weight
MA	m <sup>3</sup> /min	Pa	V	Hz	A	min <sup>-1</sup>	kW	μF/V	kg
MA-05A/T	2,7	650	230/400	50	0,52/0,30	2850	0,04	–	5,6
MA-05A/S	2,7	650	230	50	0,80	2920	0,04	3/450	5,8
MA-10A/T	4,9	1000	230/400	50	0,55/0,32	2750	0,075	–	8,5
MA-10A/S	4,9	1000	230	50	0,65	2700	0,075	8/450	8,6
MA-20A/T	11	1000	230/400	50	1,26/0,73	2790	0,25	–	10,2
MA-20A/S	11	1000	230	50	1,8	2800	0,25	12/450	10,7
MA-30A/T	11	2000	230/400	50	1,73/1,00	2825	0,37	–	18,5
MA-30A/S	11	2000	230	50	2,5	2825	0,37	12/450	20,4
MA-30B/T	13,5	2200	230/400	50	2,5/1,45	2840	0,55	–	19
MA-30B/S	13,5	2200	230	50	3,6	2820	0,55	16/450	20,7
MA-40A/T	18	2100	230/400	50	2,5/1,45	2840	0,55	–	24,0
MA-40A/S	18	2100	230	50	3,6	2840	0,55	16/450	24,8
MA-40B/T	21,0	2500	230/400	50	3,4/1,95	2820	0,75	–	24,2
MA-40B/S	21,0	2500	230	50	5,0	2800	0,75	20/450	26,5
MA-50A/T	27,5	3000	230/400	50	5,0/2,85	2800	1,1	–	33
MA-50B/T	35	3100	230/400	50	6,2/3,6	2825	1,5	–	36
MA-60A/T	50	3600	230/400	50	8,7/5,0	2875	2,2	–	44
MA-60B/T	42,5	3500	230/400	50	10,6/6,1	2880	3,0	–	47,5
MA-60C/T	60,5	3500	400 Δ	50	8,2	2905	4,0	–	59,5
MA-70A/T	55	5200	400 Δ	50	11,3	2910	5,5	–	95
MA-70B/T	88	5200	400 Δ	50	14,7	2915	7,5	–	106
MA-70C/T	90	6800	400 Δ	50	21,5	2910	11,0	–	127
MA-80A/T	125	8300	400 Δ	50	27	2940	15	–	max. 219
MA-80B/T	125	9600	400 Δ	50	40,5	2925	22	–	max. 260

Deviation in the revointion of ± 5 % are possible.

# PERFORMANCE CURVE MA

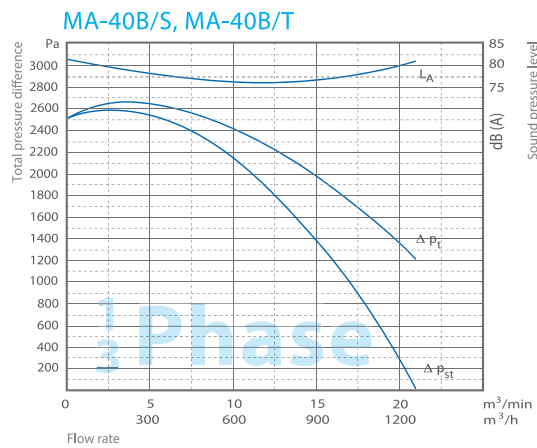
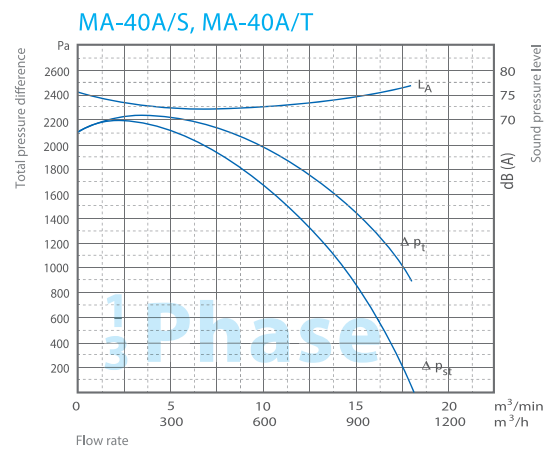
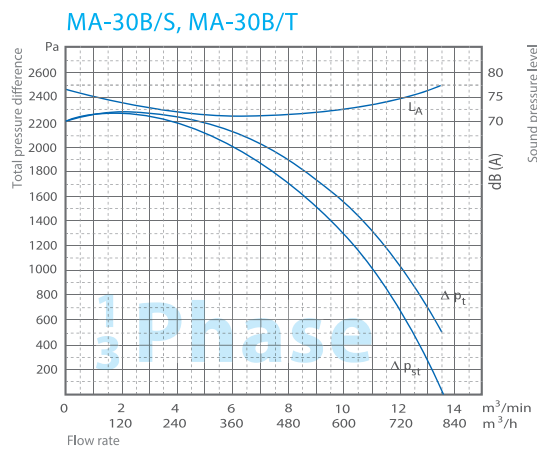
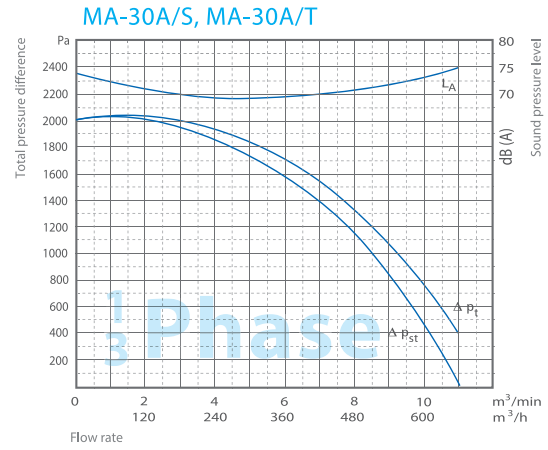
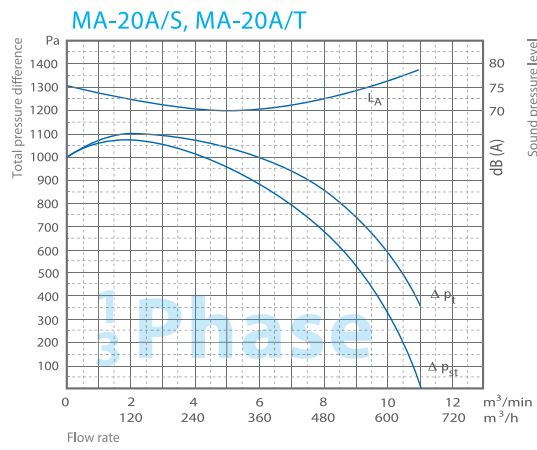
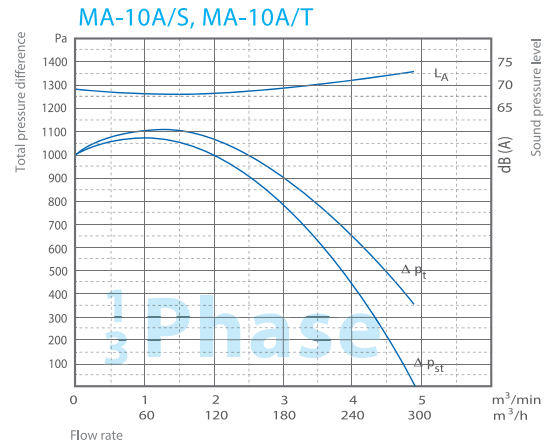
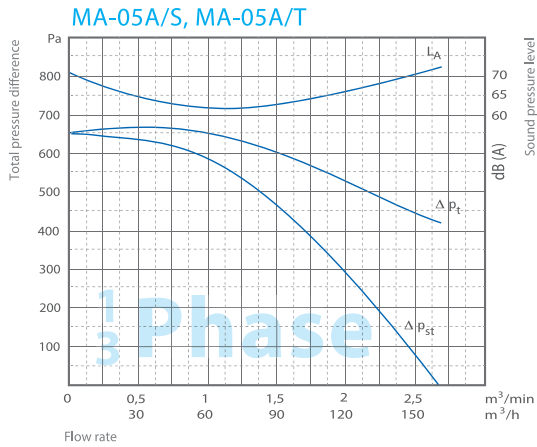

# PERFORMANCE CURVE MA

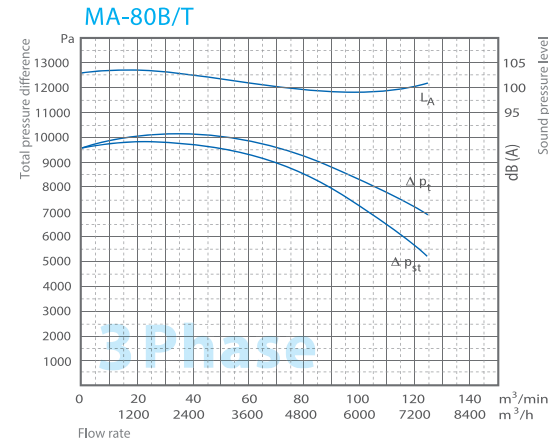
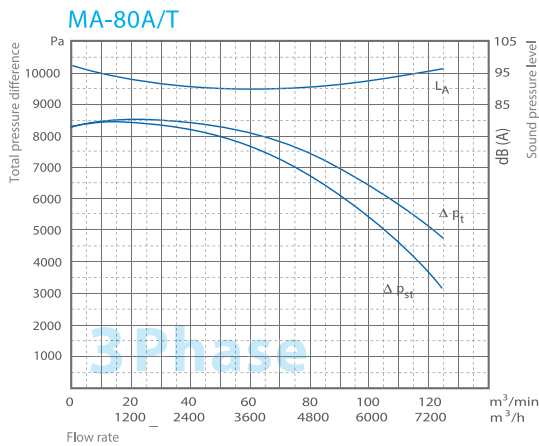
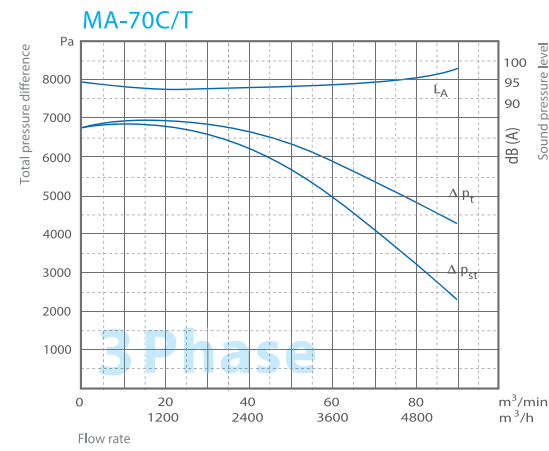
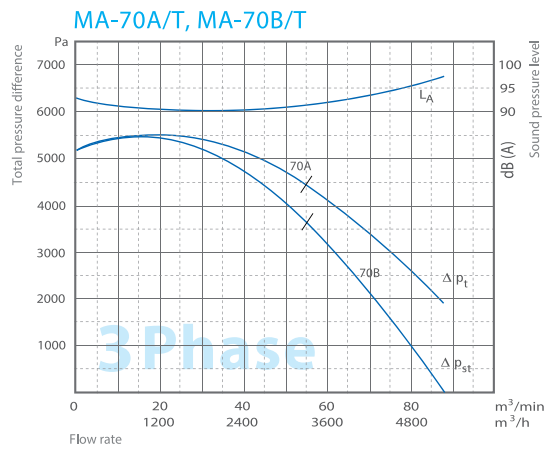
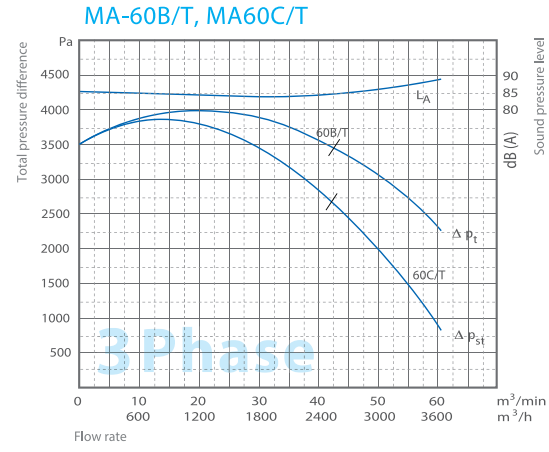
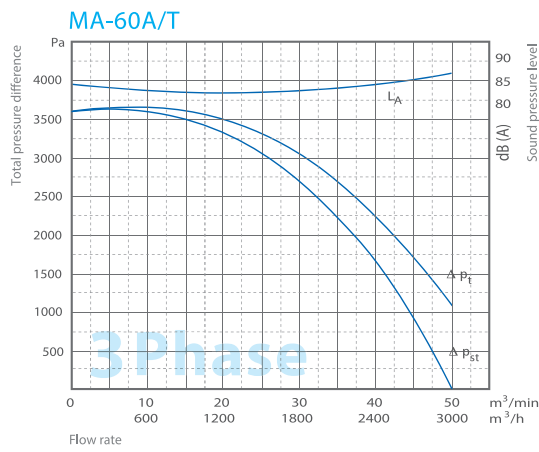
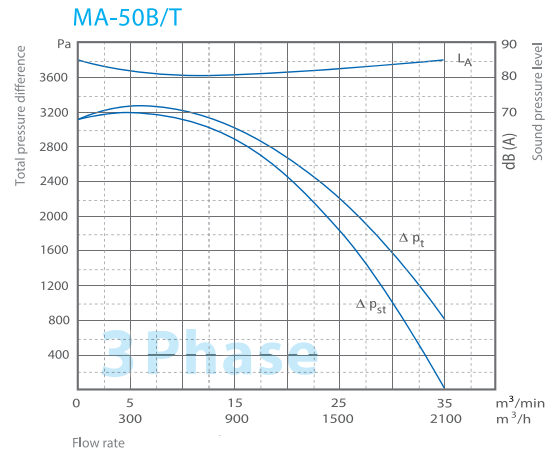
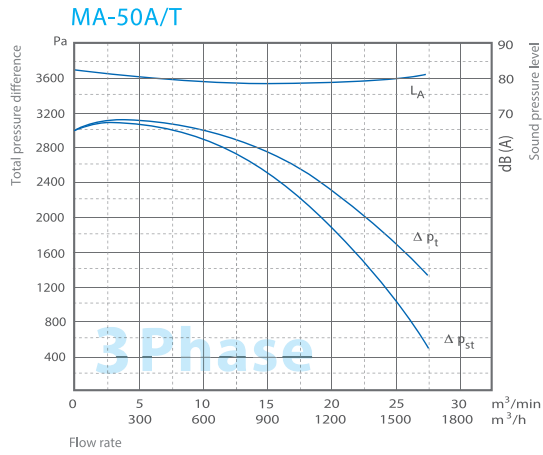

# TECHNICAL INFORMATION MSR, MSS

Type	Max flow rate	Total pressure difference	Voltage	Frequency	Current Consumption	Motor rating	Number of revolutions	Weight
MSR	m <sup>3</sup> /min	Pa	V	Hz	A	kW	min <sup>-1</sup>	kg
MSR-20A/T	10,5	1100	230/400	50	1,26/0,73	2790	0,25	10,2
MSR-30A/T	15,5	2000	230/400	50	3,4/1,95	2820	0,75	24,0
MSR-40A/T	19,5	2200	230/400	50	5,0/2,85	2800	1,1	26,0
MSR-40B/T	24	2500	230/400	50	6,2/3,6	2825	1,5	30
MSR-50A/T	33	3100	230/400	50	8,7/5,0	2875	2,2	37
MSR-50B/T	42	3500	230/400	50	10,6/6,1	2880	3,0	47,5
MSR-60A/T	61	3800	400 Δ	50	11,0	2900	5,5	59,5
MSR-70B/T	64	6800	400 Δ	50	22	2950	11,0	136
MSS	m <sup>3</sup> /min	Pa	V	Hz	A	kW	min <sup>-1</sup>	kg
MSS-55A/T	25	1900	230/400	50	7,4/4,3	2830	1,8	79
MSS-55B/T	30	2200	230/400	50	10,0/5,8	2860	2,6	82
MSS-65A/T	50	3400	400 Δ	50	9,6	2900	4,3	113
MSS-65B/T	60	3900	400 Δ	50	12,0	2900	6,0	117

Deviation in the revoinction of ± 5 % are possible

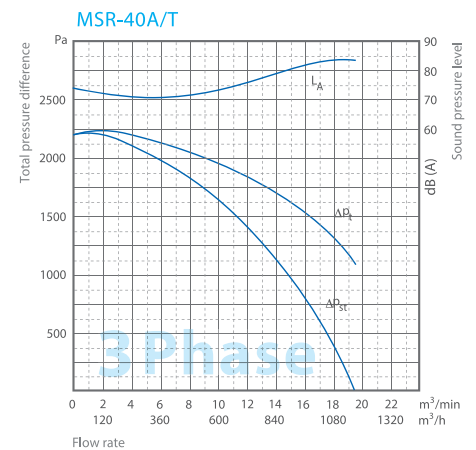
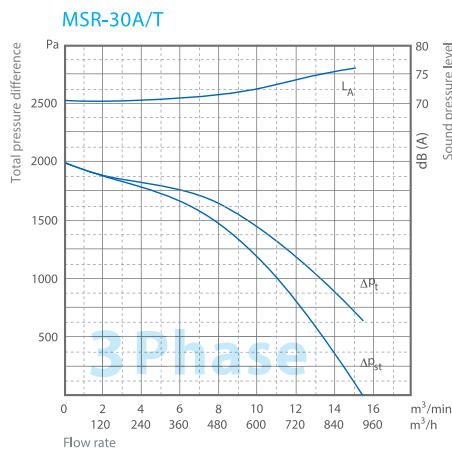
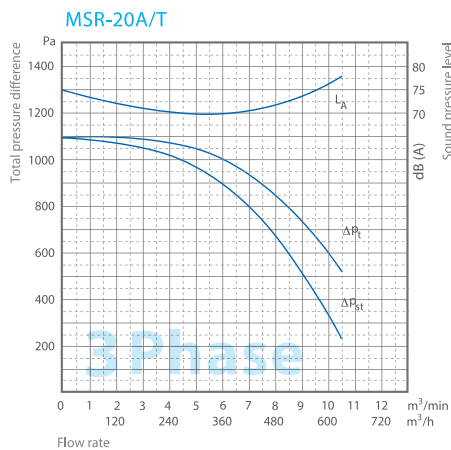

# PERFORMANCE CURVE MSR, MSS

MSR-40B/T

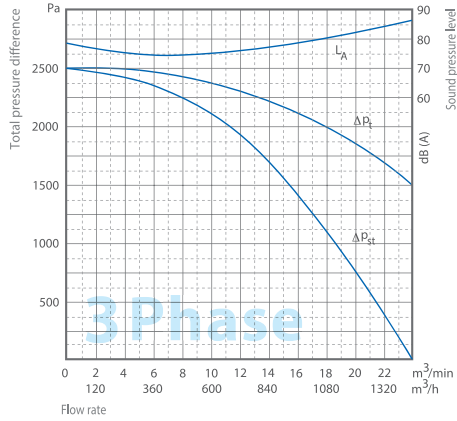

MSR-50A/T

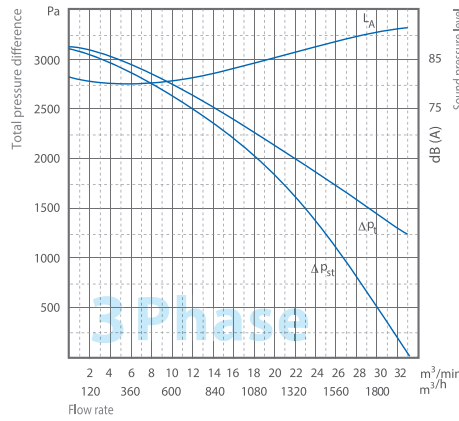

MSR-50B/T

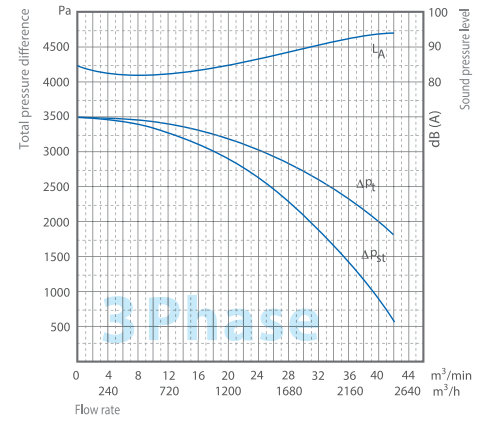

MSR-60A/T

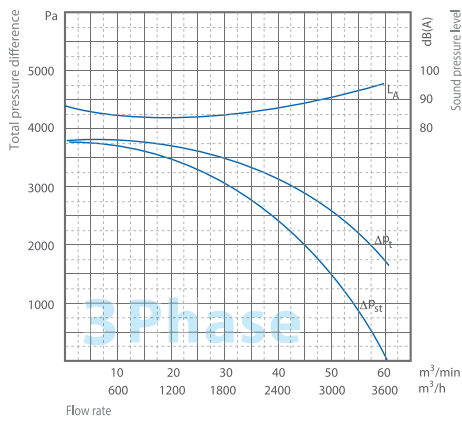

MSR-70B/T

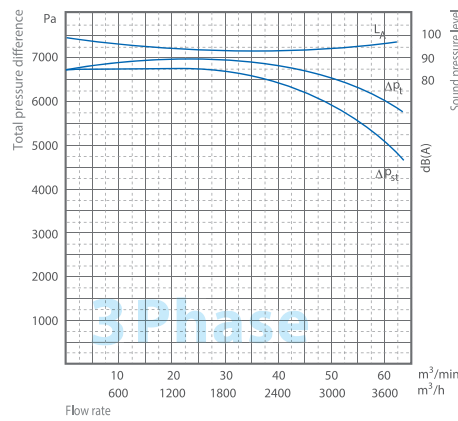

MSS-55A/T

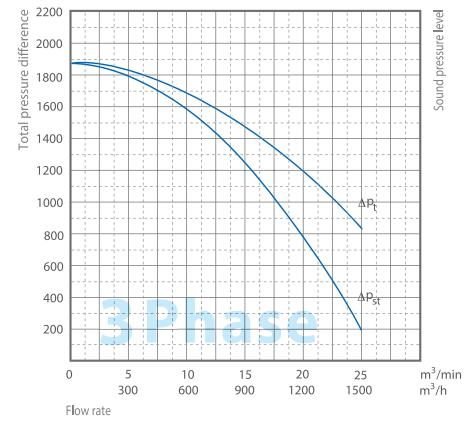

MSS-55B/T

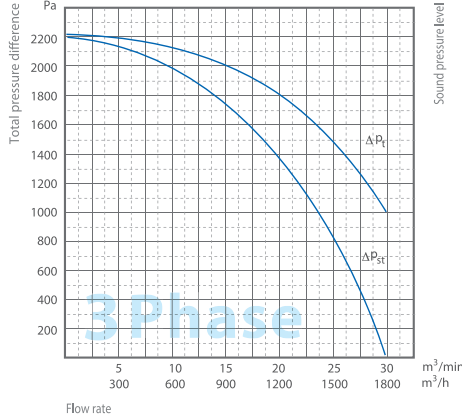

MSS-65A/T

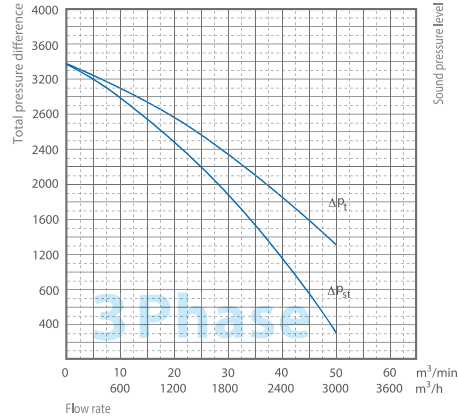

MSS-65B/T

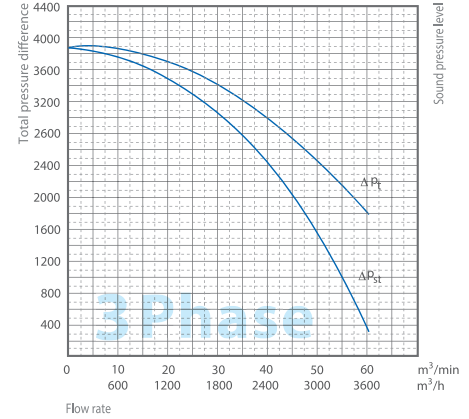



# DIMENSION MA, MSR, MSS

MA-05 to MA-60, MSR-20 to MSR-60, MSS-55 to MSS-65

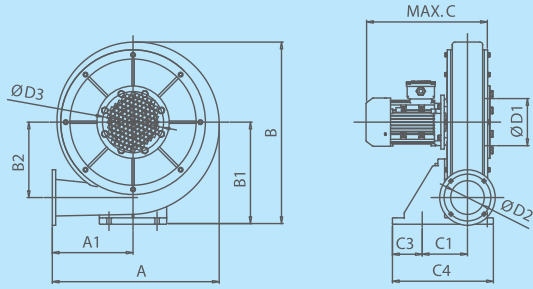

MA-70, MSR-70

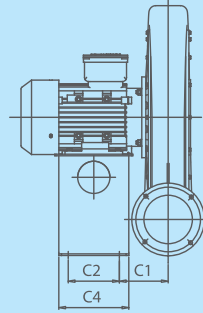

MA-80

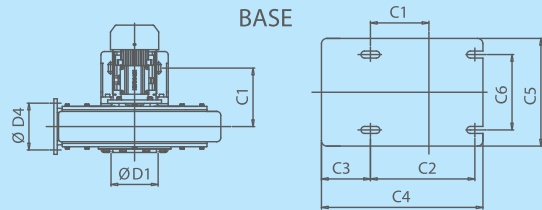
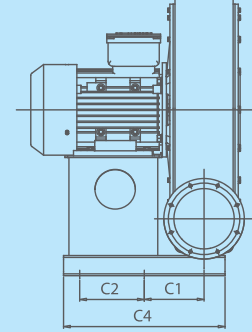

INLET

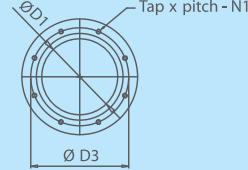

OUTLET

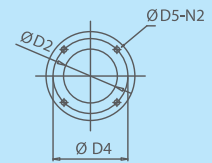

MODEL	A	A1	B	B1	B2	C	C1	C2	C3	C4	C5	C6	ØD1	ØD2	ØD3	ØD4	ØD5	N1	N2	Tap x pitch
MA-05A/S,T	252	120	267	143	96	220	52	-	28	115	110	73	80	46	-	75	9	-	4	-
MA-10A/S,T	305	157	317	174	112	300	80	103	50	180	117	82	72	65	118	95	10	4	4	M8 x 1.25
MA-20A/S,T	362	180	375	210	120	330	93	-	36	188	120	80	98	100	140	135	10	4	4	M8 x 1.25
MA-30A/S,T	454	220	508	290	199	400	128	194	91	300	200	140	105	100	140	139	10	4	4	M8 x 1.25
MA-30B/S,T	454	220	508	290	199	400	128	194	91	300	200	140	105	100	140	139	10	4	4	M8 x 1.25
MA-40A/S,T	496	240	543	305	219	420	131	194	91	300	200	140	130	100	165	139	10	4	4	M8 x 1.25
MA-40B/S,T	496	240	543	305	219	420	131	194	91	300	200	140	141	100	182	139	10	8	4	M10 x 1.5
MA-50A/T	520	250	577	330	227	420	295	150	25	300	230	180	145	125	182	165	10	8	4	M10 x 1.5
MA-50B/T	563	274	629	360	246	480	295	150	35	300	230	160	140	140	182	182	12	8	8	M10 x 1.5
MA-60A/T	625	295	687	387	275	550	265	260	25	300	230	180	160	160	200	200	12	8	8	M10 x 1.5
MA-60B/T	625	295	687	387	275	550	265	260	25	300	230	180	160	160	200	200	12	8	8	M10 x 1.5
MA-60C/T	625	295	687	387	275	550	265	260	25	300	230	180	160	160	200	200	12	8	8	M10 x 1.5
MA-70A/T	842	395	922	508	380	580	180	190	35	260	425	386	190	180	260	240	14	8	4	M8 x 1.25
MA-70B/T	842	395	922	508	380	580	180	190	35	260	425	386	190	180	260	240	14	8	4	M8 x 1.25
MA-70C/T	842	395	922	508	380	580	180	190	35	260	425	386	190	180	260	240	14	8	4	M8 x 1.25
MA-80A/T	937	440	1078	616	405	770	222	240	60	600	500	470	221	224	265	265	12	8	8	M10 x 1.5
MA-80B/T	937	440	1078	616	405	770	222	240	60	600	500	470	221	224	265	265	12	8	8	M10 x 1.5
MA-80C/T	937	440	1078	616	405	770	222	240	60	600	500	470	221	224	265	265	12	8	8	M10 x 1.5
MSR-20A/T	362	180	375	210	120	330	93	-	36	188	120	80	98	100	140	135	10	4	4	M8 x 1.25
MSR-30A/T	454	220	508	290	199	400	128	194	91	300	200	140	105	100	140	139	10	4	4	M8 x 1.25
MSR-40A/T	496	240	543	305	219	420	131	194	91	300	200	140	130	100	165	139	10	4	4	M8 x 1.25
MSR-40B/T	496	240	543	305	219	420	131	194	91	300	200	140	141	100	182	139	10	8	4	M10 x 1.5
MSR-50A/T	520	250	577	330	227	420	295	150	25	300	230	180	145	125	182	165	10	8	4	M10 x 1.5
MSR-50B/T	563	274	629	360	246	480	295	150	35	300	230	160	140	140	182	182	12	8	8	M10 x 1.5
MSR-60A/T	625	295	687	387	275	550	265	260	25	300	230	180	160	160	200	200	12	8	8	M10 x 1.5
MSR-70B/T	842	395	922	508	380	580	180	190	35	260	425	386	190	180	260	240	14	8	4	M8 x 1.25
MSS-55A/T	520	250	577	330	227	420	295	150	25	300	230	180	145	125	182	165	10	8	4	M10 x 1.5
MSS-55B/T	563	274	629	360	246	480	295	150	35	300	230	160	140	140	182	182	12	8	8	M10 x 1.5
MSS-65A/T	625	295	687	387	275	550	265	260	25	300	230	180	160	160	200	200	12	8	8	M10 x 1.5
MSS-65B/T	625	295	687	387	275	550	265	260	25	300	230	180	160	160	200	200	12	8	8	M10 x 1.5

# TECHNICAL INFORMATION AND PERFORMANCE CURVE

## Belt Drive Aluminium Blower



**MAb 10 A /T**

/S : With single phase AC motor  
/T : With three phase AC motor

Motor size

Construction size

MAB : backward impeller with belt drive

MAB-10A to MAB-30C

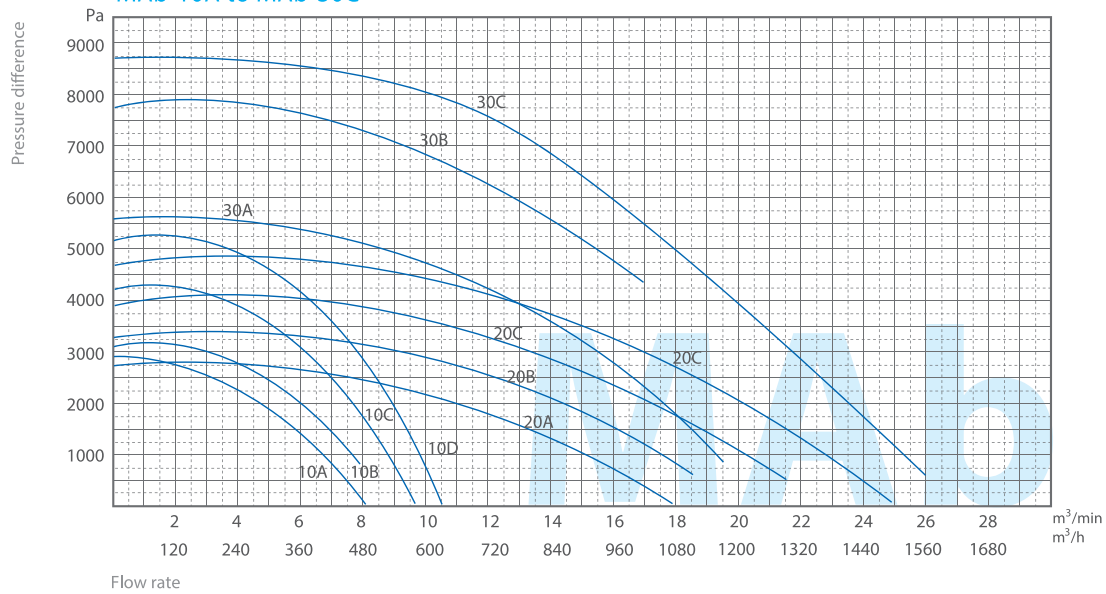

MA-50A to MA-60C

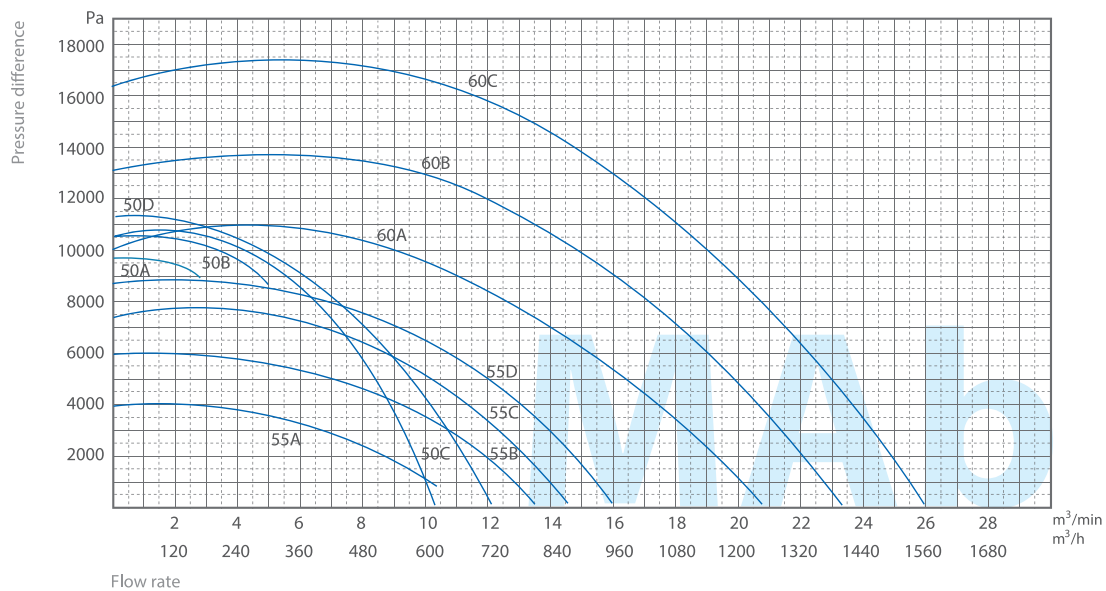

# TECHNICAL INFORMATION MAb

Type	Max flow rate	Total pressure difference	Voltage	Frequency	Current consumption	Motor rating	Number of revolutions	Blower speed	Weight
MAb	m <sup>3</sup> /min	Pa	V	Hz	A	kW	min <sup>-1</sup>	min <sup>-1</sup>	kg
MAb-10A/T	8,0	2800	230/400	50	2,5/1,45	0,55	2840	4550	18
MAb-10B/T	7,8	3300	230/400	50	2,5/1,45	0,55	2840	5500	18,5
MAb-10C/T	9,5	4200	230/400	50	3,4/1,95	0,75	2820	5500	21
MAb-10D/T	10,5	5100	230/400	50	5,0/2,85	1,1	2800	6000	23,5
MAb-20A/T	18	2600	230/400	50	5,0/2,85	1,1	2800	4500	22
MAb-20B/T	18,5	3200	230/400	50	5,0/2,85	1,1	2800	4950	24
MAb-20C/T	21,5	3900	230/400	50	6,2/3,6	1,5	2825	5500	26
MAb-20D/T	25	4500	230/400	50	8,7/5,0	2,2	2875	6000	29
MAb-30A/T	19,5	5600	230/400	50	6,2/3,6	1,5	2825	4500	32
MAb-30B/T	17	7700	230/400	50	10,6/6,10	3,0	2880	5200	36
MAb-30C/T	26	8600	230/400	50	10,6/6,1	3,0	2880	5600	40
MAb-50A/T	11,5	9700	230/400	50	10,6/6,1	3,0	2880	6100	55
MAb-50B/T	20	10150	400 Δ	50	8,2	4,0	2905	6100	67
MAb-50C/T	38	10150	400 Δ	50	11,3	5,5	2910	6100	67
MAb-50D/T	47	11400	400 Δ	50	14,7	7,5	2915	6350	87
MAb-55A/T	40	3900	230/400	50	8,7/5,0	2,2	2875	3900	63
MAb-55B/T	52	5900	400 Δ	50	8,2	4,0	2905	4850	73
MAb-55C/T	56	7500	400 Δ	50	11,3	5,5	2910	5300	73
MAb-55D/T	62	8700	400 Δ	50	14,7	7,5	2915	5800	89
MAb-60A/T	80	10000	400 Δ	50	21,5	11	2910	4950	190
MAb-60B/T	90	13000	400 Δ	50	32,5	18,5	2940	5600	max. 250
MAb-60C/T	96	16400	400 Δ	50	40,5	22	2925	6350	max. 270

Deviation in the revointion of ± % are possible

# PERFORMANCE CURVE MAb

MAb-10A/T

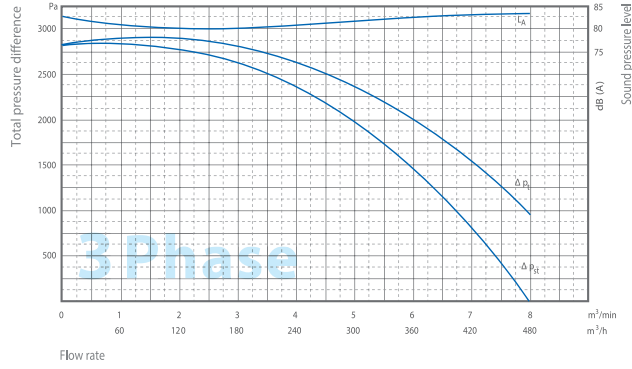

MAb-10B/T

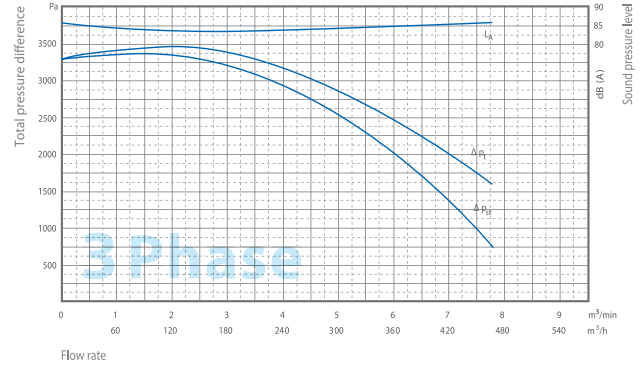

MAb-10C/T

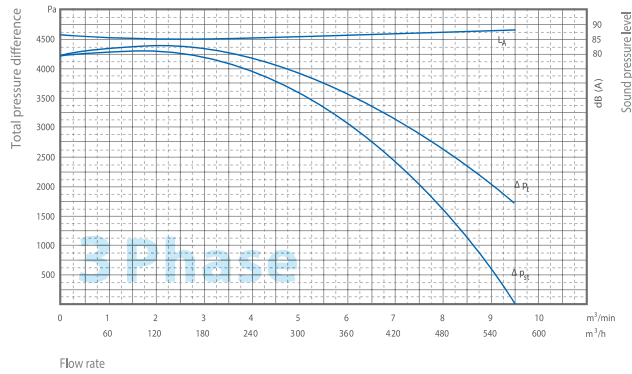

MAb-10D/T

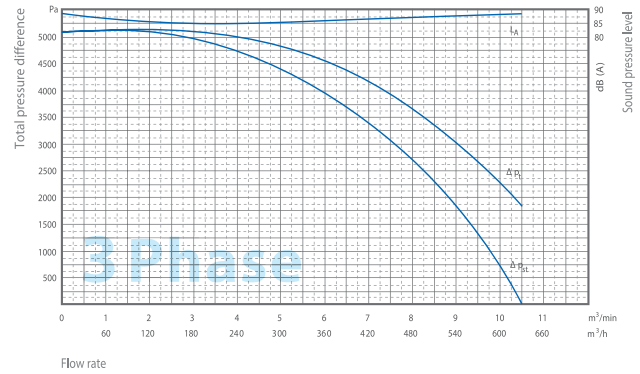

MAB-20A/T

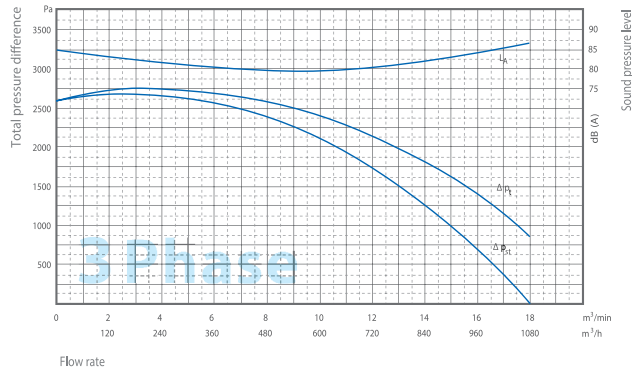

MAB-20B/T

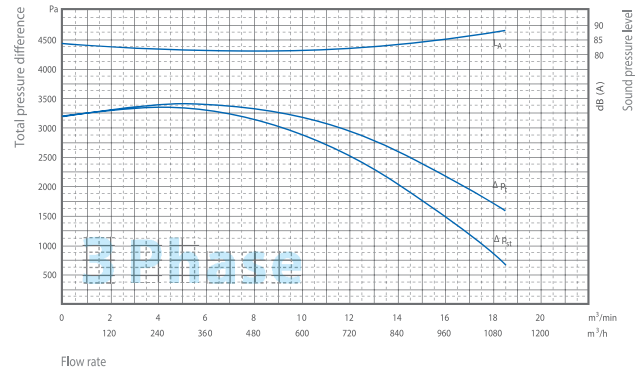

MAb-20C/T

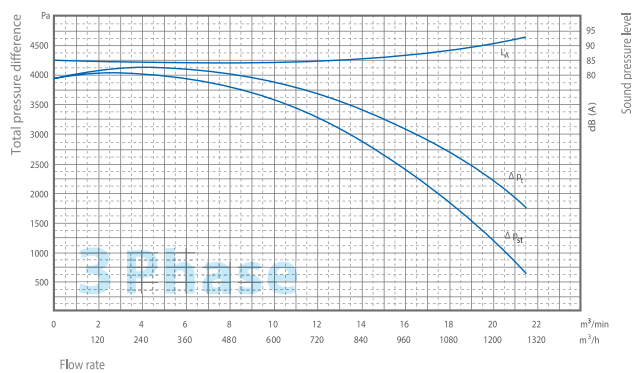

MAB-20D/T

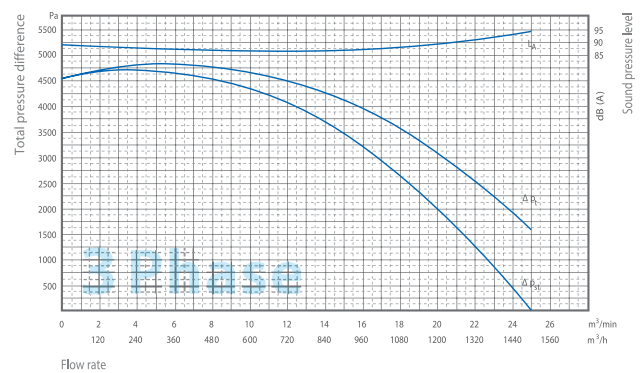

# PERFORMANCE CURVE MAb

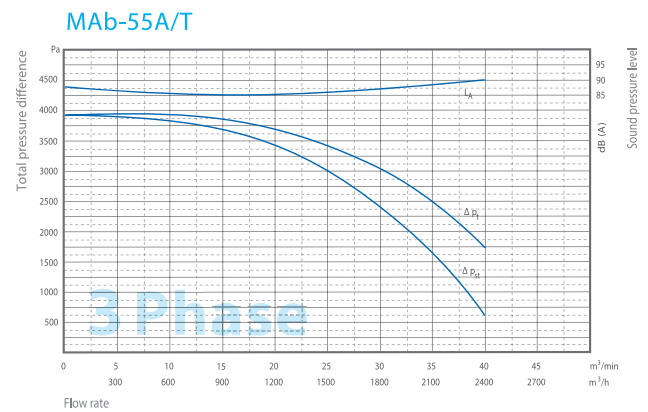
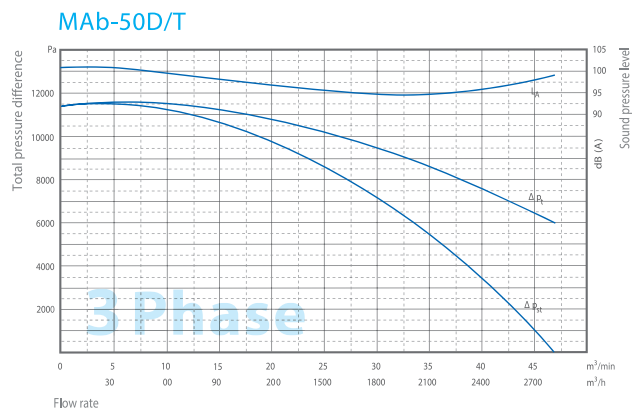
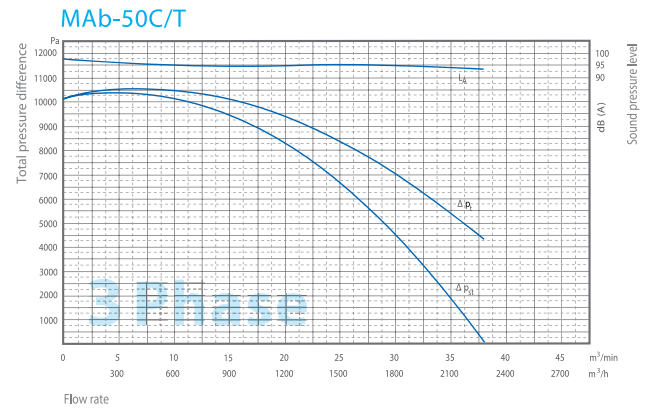
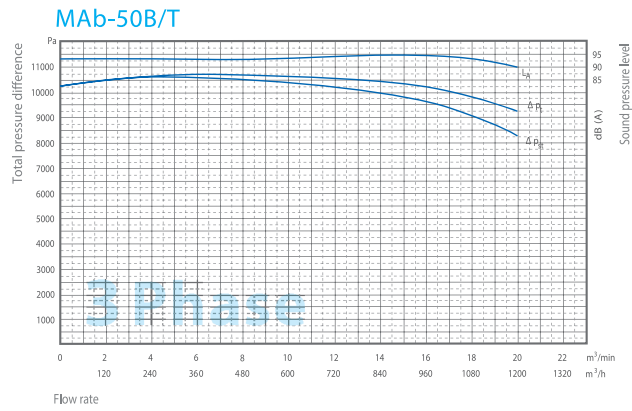
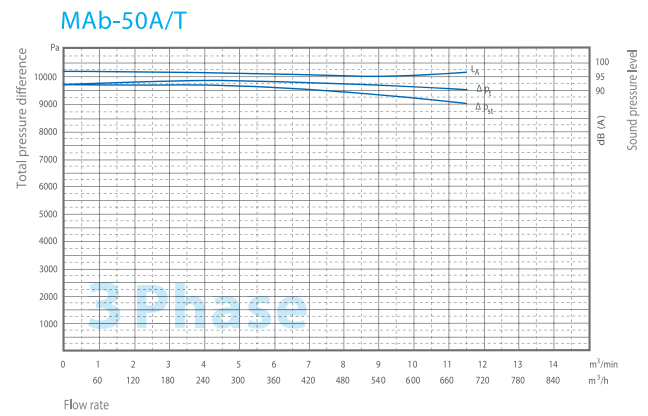
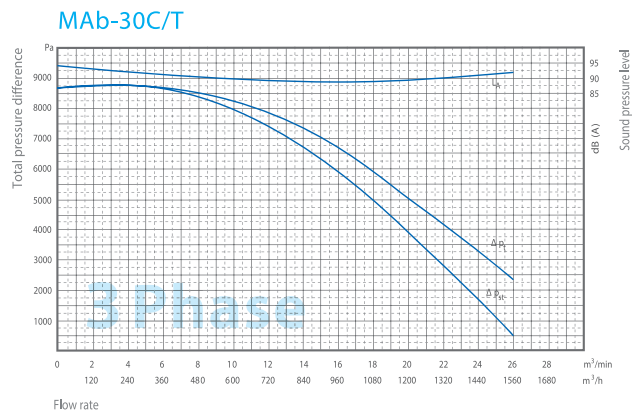
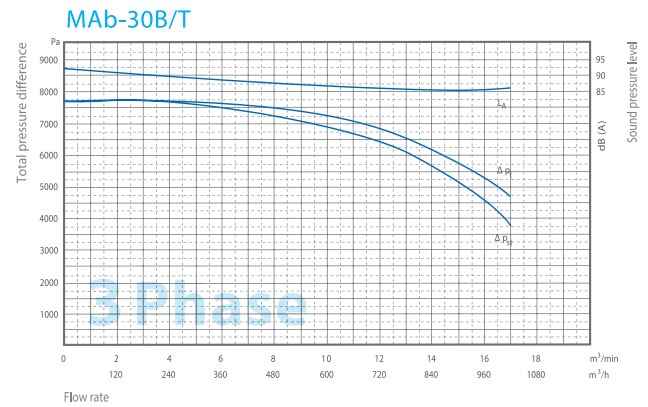
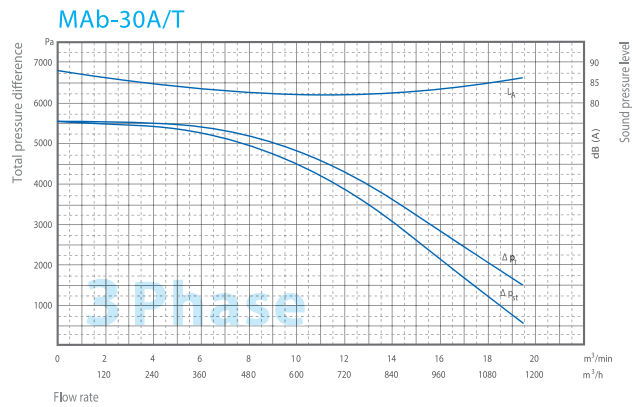

# PERFORMANCE CURVE MAb

MAb-55B/T

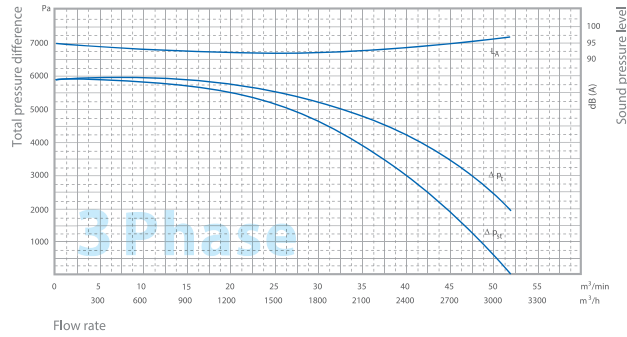

MAb-55C/T

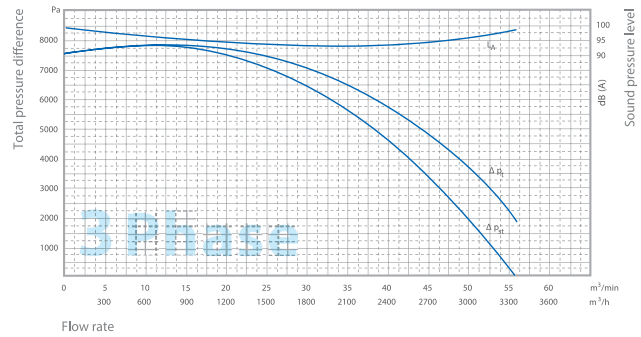

MAb-55D/T

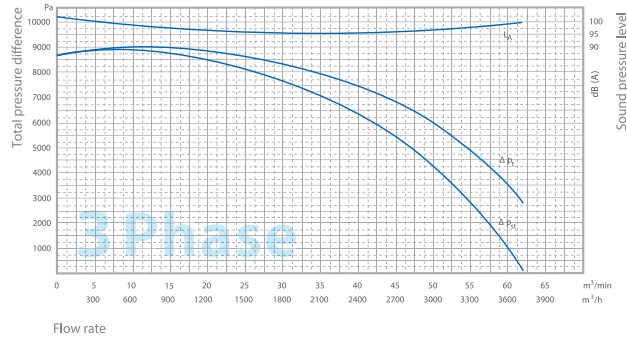

MAb-60A/T

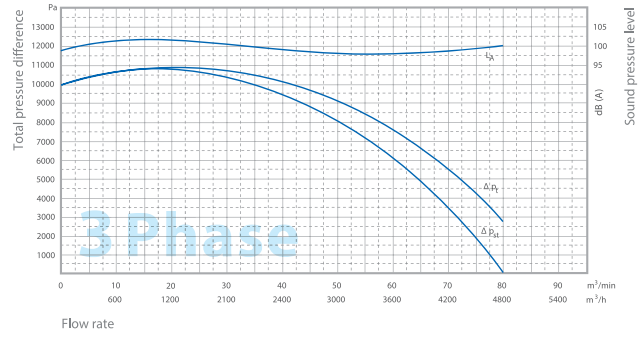

MAb-60B/T

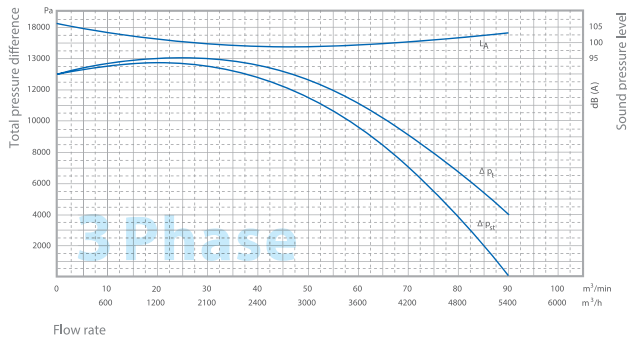

MAb-60C/T

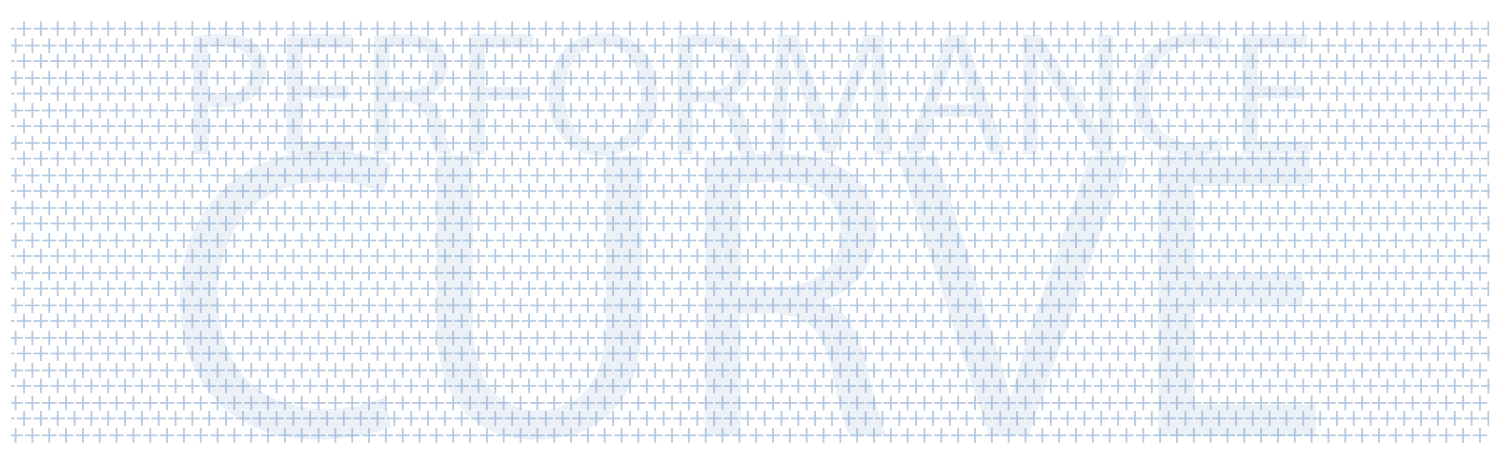
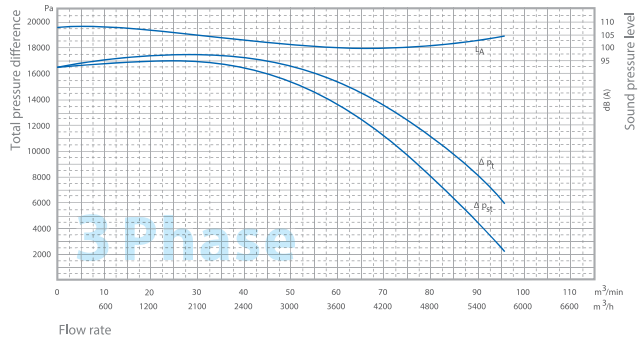

# DIMENSION MAb

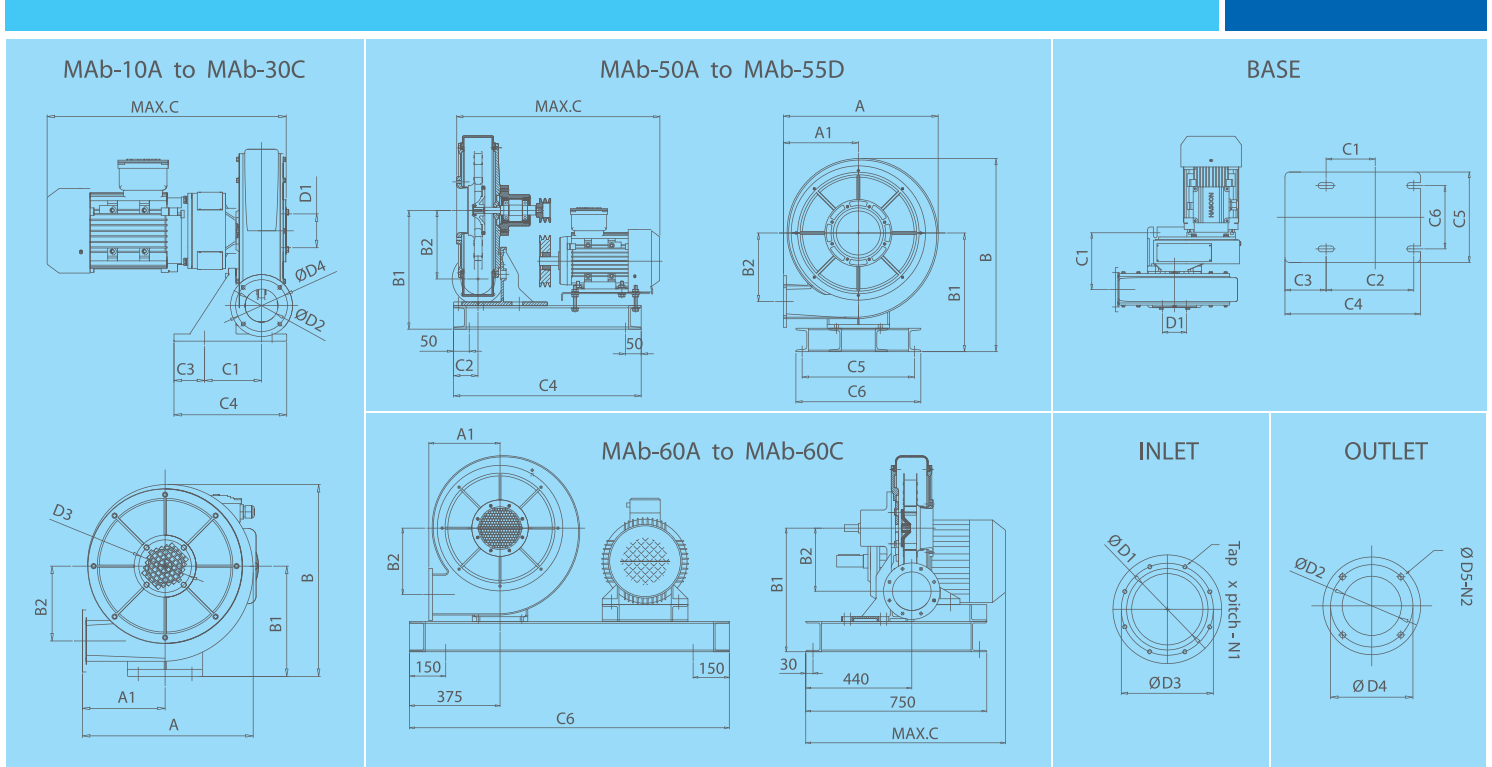

MODEL	A	A1	B	B1	B2	C	C1	C2	C3	C4	C5	C6	ØD1	ØD2	ØD3	ØD4	ØD5	N1	N2	Tap x pitch
MAb-10A/T	305	157	317	174	112	500	80	103	50	180	117	82	72	65	118	95	10	4	4	M8 x 1.25
MAb-10B/T	305	157	317	174	112	500	80	103	50	180	117	82	72	65	118	95	10	4	4	M8 x 1.25
MAb-10C/T	305	157	317	174	112	500	80	103	50	180	117	82	72	65	118	95	10	4	4	M8 x 1.25
MAb-10D/T	305	157	317	174	112	500	80	103	50	180	117	82	72	65	118	95	10	4	4	M8 x 1.25
MAb-20A/T	362	180	375	210	120	500	93	-	36	188	120	80	98	100	140	135	10	4	4	M8 x 1.25
MAb-20B/T	362	180	375	210	120	500	93	-	36	188	120	80	98	100	140	135	10	4	4	M8 x 1.25
MAb-20C/T	362	180	375	210	120	500	93	-	36	188	120	80	98	100	140	135	10	4	4	M8 x 1.25
MAb-20D/T	362	180	375	210	120	500	93	-	36	188	120	80	98	100	140	135	10	4	4	M8 x 1.25
MAb-30A/T	454	220	508	290	199	650	128	194	91	300	200	140	105	100	140	139	10	4	4	M8 x 1.25
MAb-30B/T	454	220	508	290	199	650	128	194	91	300	200	140	105	100	140	139	10	4	4	M8 x 1.25
MAb-30C/T	454	220	508	290	199	650	128	194	91	300	200	140	105	100	140	139	10	4	4	M8 x 1.25
MAb-50A/T	496	240	620	380	219	700	-	78	-	600	360	400	141	100	182	139	10	8	4	M10 x 1.5
MAb-50B/T	496	240	620	380	219	700	-	78	-	600	360	400	141	100	182	139	10	8	4	M10 x 1.5
MAb-50C/T	496	240	620	380	219	700	-	78	-	600	360	400	141	100	182	139	10	8	4	M10 x 1.5
MAb-50D/T	496	240	620	380	219	700	-	78	-	600	360	400	141	100	182	139	10	8	4	M10 x 1.5
MAb-55A/T	560	280	690	431	237	750	-	118	-	635	360	400	156	140	200	182	12	8	8	M8x 1.25
MAb-55B/T	560	280	690	431	237	750	-	118	-	635	360	400	156	140	200	182	12	8	8	M8x 1.25
MAb-55C/T	560	280	690	431	237	750	-	118	-	635	360	400	156	140	200	182	12	8	8	M8x 1.25
MAb-55D/T	560	280	690	431	237	750	-	118	-	635	360	400	156	140	200	182	12	8	8	M8x 1.25
MAb-60A/T	625	295	812	512	275	900	-	-	-	-	-	1325	160	160	200	200	12	8	8	M10x 1.5
MAb-60B/T	625	295	812	512	275	900	-	-	-	-	-	1325	160	160	200	200	12	8	8	M10x 1.5
MAb-60C/T	625	295	812	512	275	900	-	-	-	-	-	1325	160	160	200	200	12	8	8	M10x 1.5